

## LOW-NOISE DUAL PRE-AMPLIFIER

### ■ GENERAL DESCRIPTION

The NJM2043 is a bipolar operational amplifier which is designed as low noise version of the NJM4558 with high output current and fast slew rate ( 6V/ $\mu$ s ) and wide unity gain bandwidth ( 14MHz ) constructed using New JRC Planar epitaxial process.

### ■ FEATURES

- Operating Voltage (  $\pm 4V \sim \pm 22V$  )
- High Output Current ( 25mA. )
- Slew Rate ( 6V/ $\mu$ s typ. )
- Unity Gain Bandwidth ( 14MHz typ. )
- Package Outline DIP8,DMP8,SIP8
- Bipolar Technology

### ■ PACKAGE OUTLINE

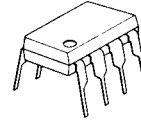

NJM2043D

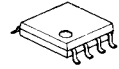

NJM2043M

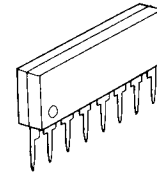

NJM2043L

### ■ PIN CONFIGURATION

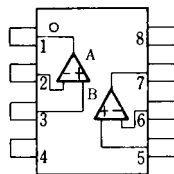

NJM2043D  
NJM2043M

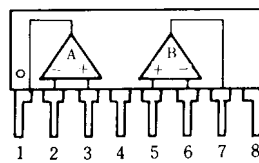

NJM2043L

### PIN FUNCTION

- 1.A OUTPUT
- 2.A -INPUT
- 3.A +INPUT
- 4.V-
- 5.B +INPUT
- 6.B -INPUT
- 7.B OUTPUT
- 8.V+

### ■ EQUIVALENT CIRCUIT ( 1/2 Shown )

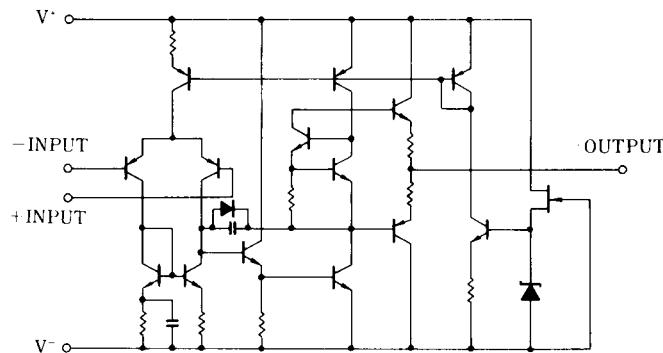

# NJM2043

## ■ ABSOLUTE MAXIMUM RATINGS

( Ta=25°C )

PARAMETER	SYMBOL	RATINGS	UNIT
Supply Voltage	$V^+ / V^-$	± 22	V
Differential Input Voltage	$V_{ID}$	± 30	V
Input Voltage	$V_{IC}$	± 15 ( note )	V
Power Dissipation	$P_D$	( DIP8 ) 500 ( DMP8 ) 300 ( SIP8 ) 800	mW
Operating Temperature Range	$T_{opr}$	-20~+75	°C
Storage Temperature Range	$T_{stg}$	-40~+125	°C

( note ) For supply voltage less than ±15V, the absolute maximum input voltage is equal to the supply voltage.

## ■ ELECTRICAL CHARACTERISTICS

( Ta=25°C,  $V^+ / V^- = \pm 15V$  )

PARAMETER	SYMBOL	TEST CONDITION	MIN.	TYP.	MAX.	UNIT
Input Offset Voltage	$V_{IO}$	$R_S \leq 10k\Omega$	-	0.3	3	mV
Input Offset Current	$I_{IO}$		-	10	200	nA
Input Bias Current	$I_B$		-	400	1000	nA
Input Resistance	$R_{IN}$		30	100	-	kΩ
Large signal Voltage Gain	$A_V$	$R_L \geq 2k\Omega, V_O = \pm 10V$	86	100	-	dB
Maximum Output Voltage Swing 1	$V_{OM1}$	$R_L \geq 10k\Omega$	± 12	± 14	-	V
Maximum Output Voltage Swing 2	$V_{OM2}$	$I_O = 25mA$	± 10	± 11.5	-	V
Input Common Mode Voltage Range	$V_{ICM}$		± 12	± 14	-	V
Common Mode Rejection Ratio	CMR	$R_S \leq 10k\Omega$	70	100	-	dB
Supply Voltage Rejection Ratio	SVR	$R_S \leq 10k\Omega$	76	100	-	dB
Operating Current	$I_{CC}$		-	6	8	mA
Slew Rate	SR		-	6	-	V/μs
Gain Bandwidth Product	GB		-	14	-	MHz
Equivalent Input Noise Voltage	$V_{NI}$	FLAT+JISA $R_S = 300\Omega$	-	0.4	0.51	μVrms

( note1 ) Closed loop gain should be more than 20dB at use.

( note2 ) New JRC's general selected products D rank are also prepared for the noise standard (  $R_S = 2.2k\Omega, R_{IAA}, V_{NI} = 1.4\mu V$  Max. )

## ■ TYPICAL CHARACTERISTICS

**Open Loop Voltage Gain vs. Frequency**

( $V^+/V^- = \pm 15V$ ,  $R_L = 2k\Omega$ ,  $T_a = 25^\circ C$ )

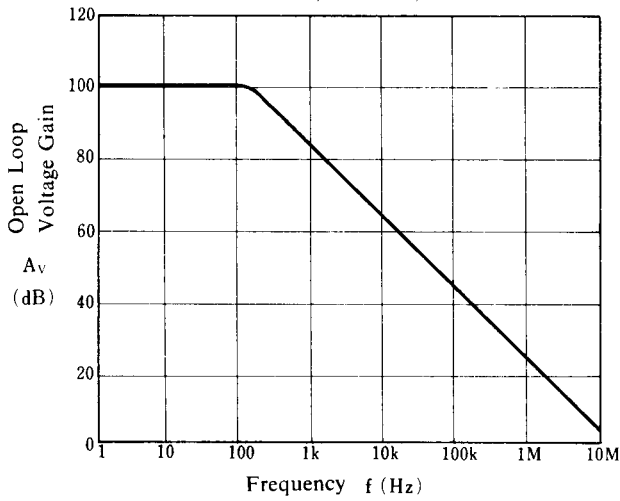

**Equivalent Input Noise Voltage**

( $V^+/V^- = \pm 15V$ ,  $T_a = 25^\circ C$ )

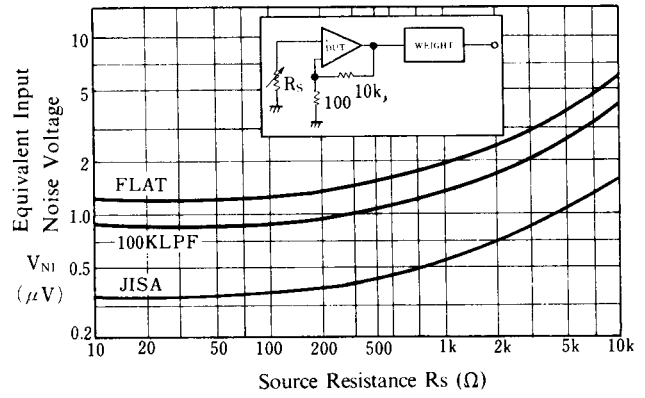

**Maximum Output Voltage Swing vs. Load Resistance**

( $V^+/V^- = \pm 15V$ ,  $T_a = 25^\circ C$ )

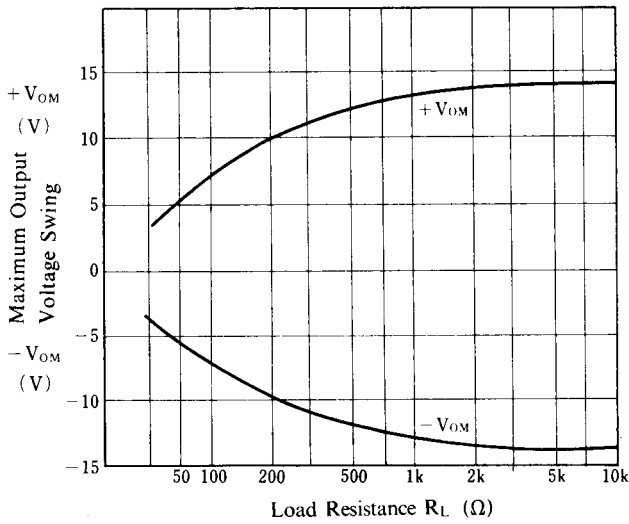

**Maximum Output Voltage Swing vs. Output Current**

( $V^+/V^- = 15V$ ,  $T_a = 25^\circ C$ )

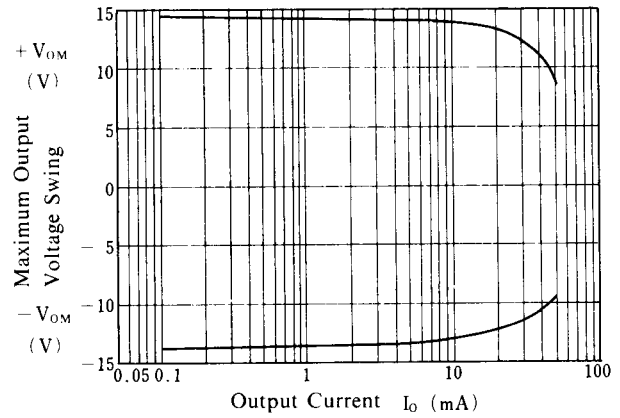

**Operating Current vs. Temperature**

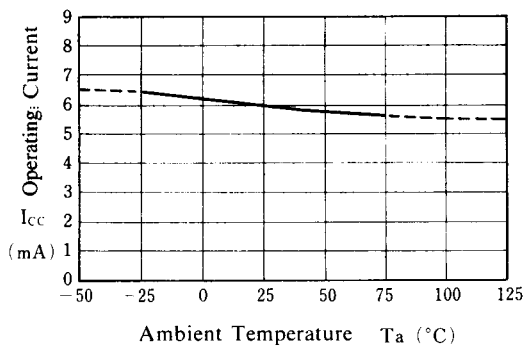

**Maximum Output Voltage Swing vs. Temperature**

( $V^+/V^- = 15V$ ,  $R_L = 10k\Omega$ )

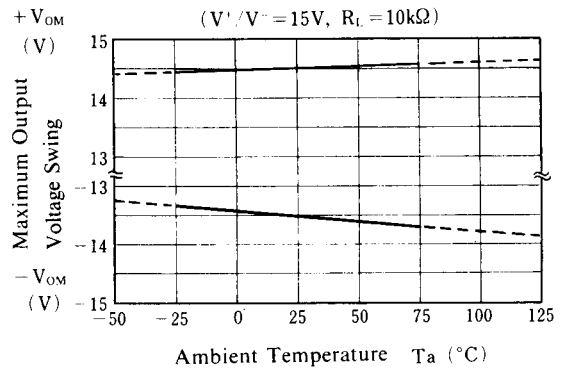

## ■ TYPICAL CHARACTERISTICS

**Input Offset Voltage vs. Temperature**

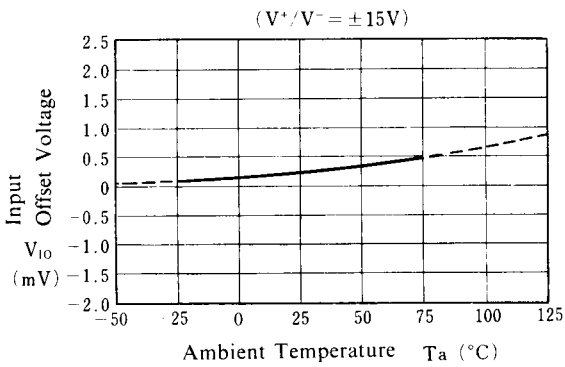

**Input Bias Current vs. Temperature**

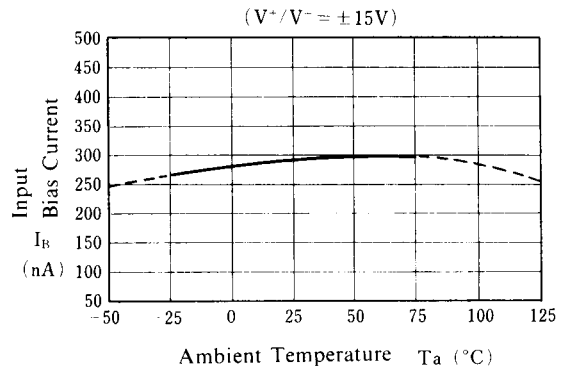

**Maximum Output Voltage Swing vs. Operating Voltage**

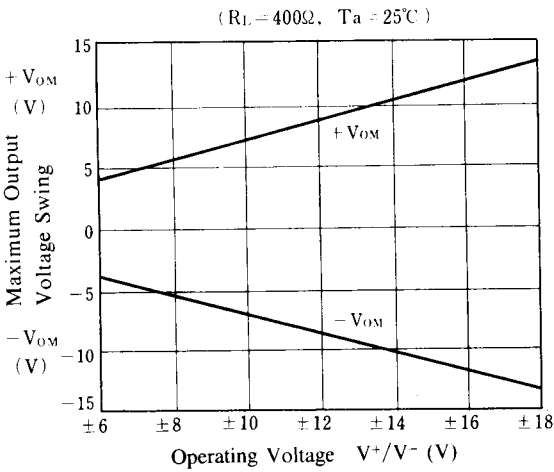

**Maximum Output Voltage Swing vs. Supply Voltage**

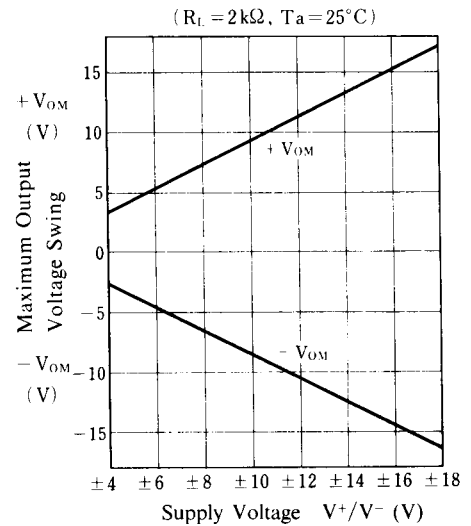

**Operating Current vs. Operating Voltage**

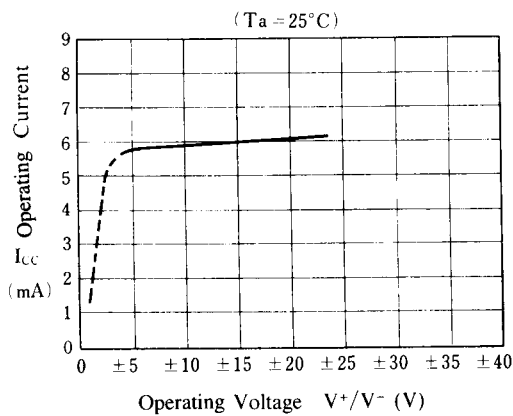

**Maximum Output Voltage Swing vs. Frequency**

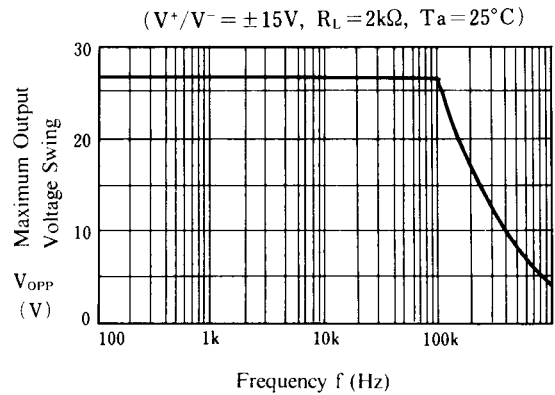

**[CAUTION]**

The specifications on this databook are only given for information, without any guarantee as regards either mistakes or omissions. The application circuits in this databook are described only to show representative usages of the product and not intended for the guarantee or permission of any right including the industrial rights.